

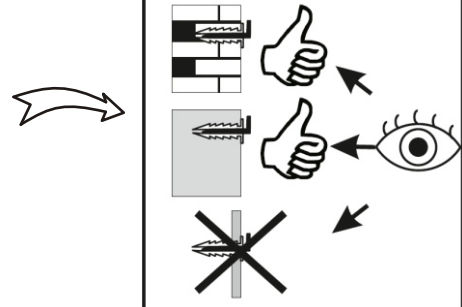

NO	Dim.		Col.-No	Qty
1	1370	750	1	1
2	594	180	1	1
3	594	180	1	1
4	150	179	3	1

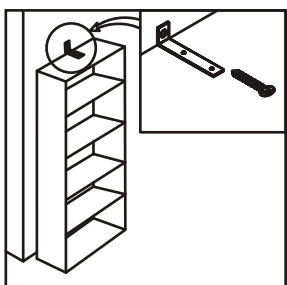

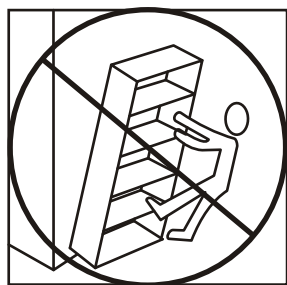
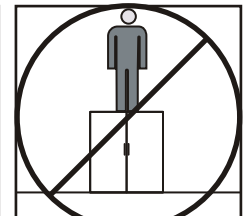
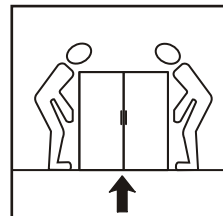
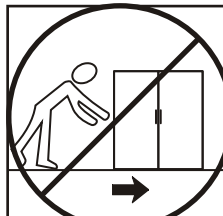
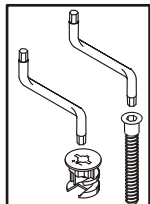
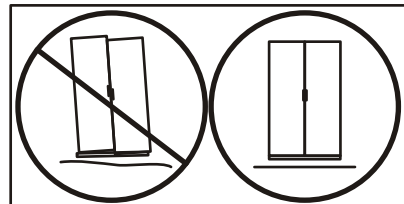
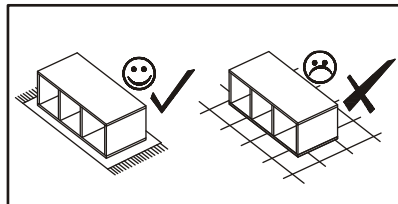
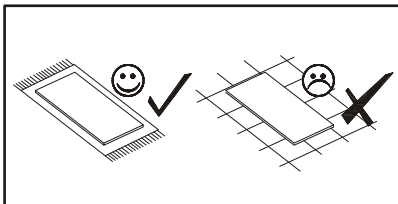
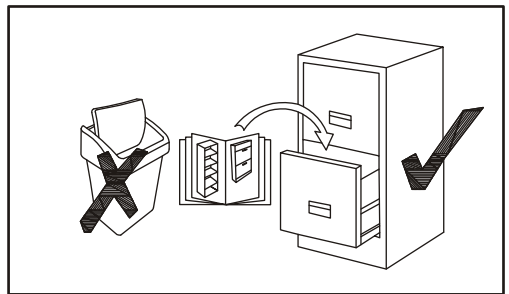
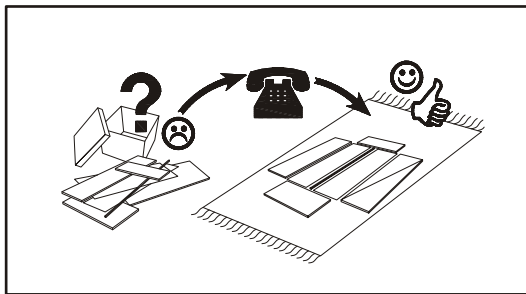
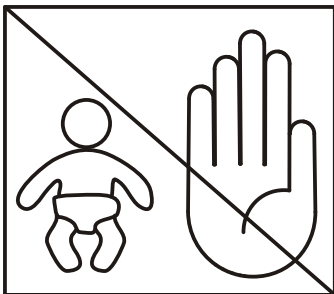
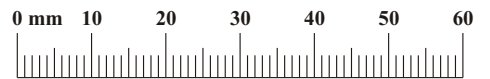
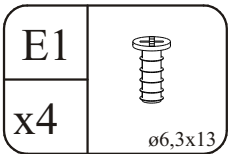
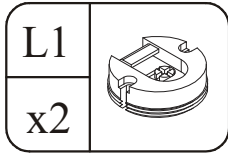
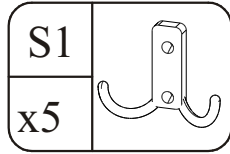
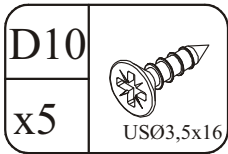
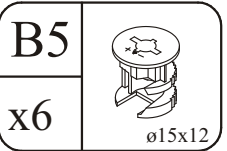
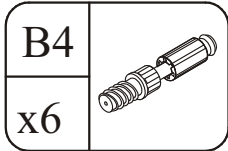
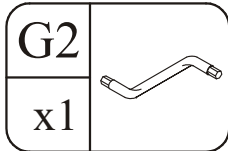
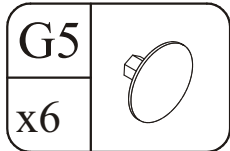
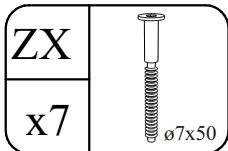
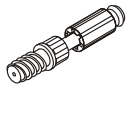

1

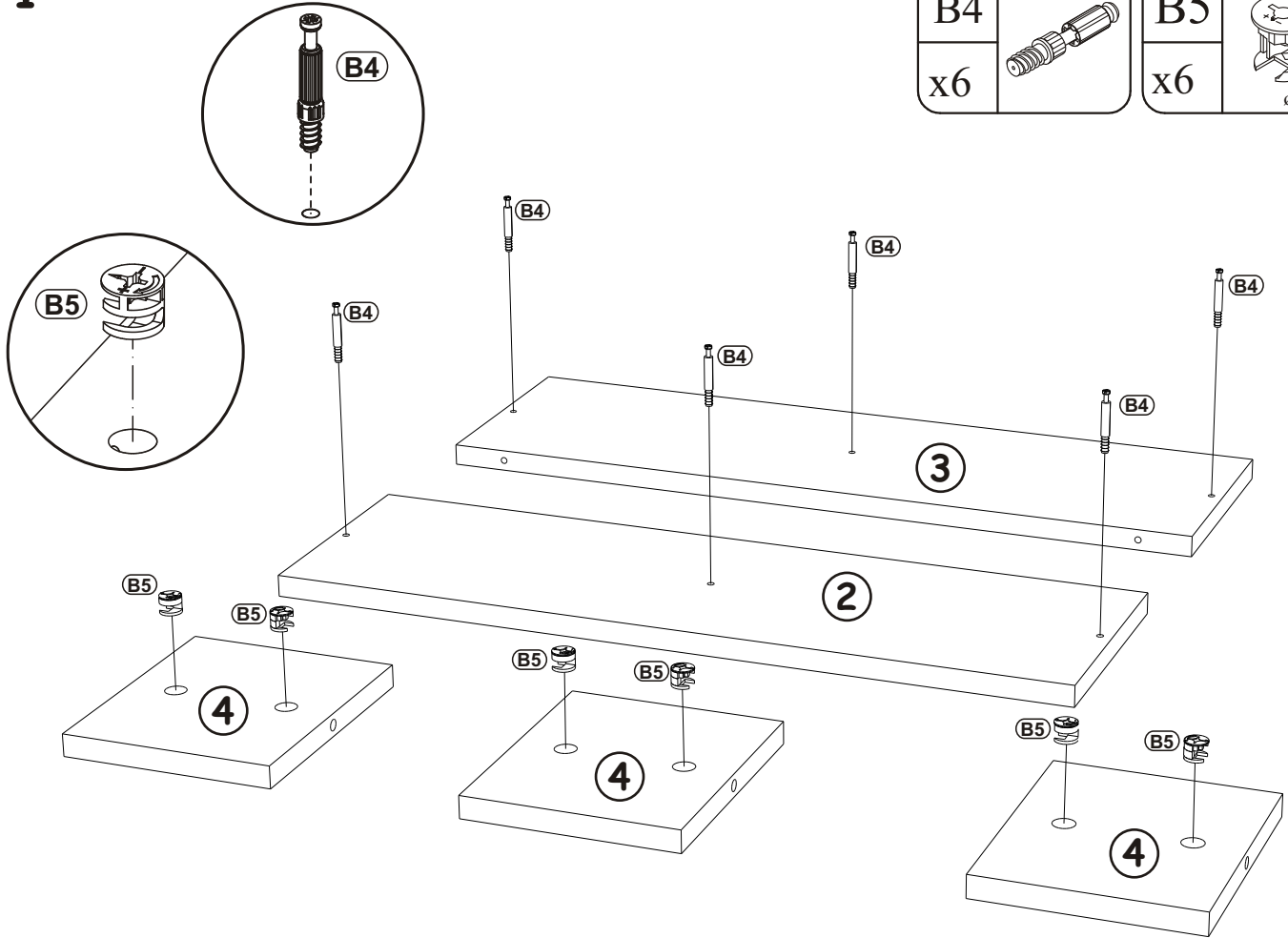
B4		B5	
x6		x6	ø15x12

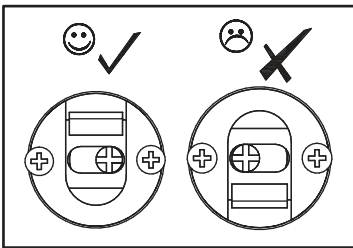

2

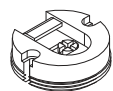

E1		L1	
x4	ø6,3x13	x2	

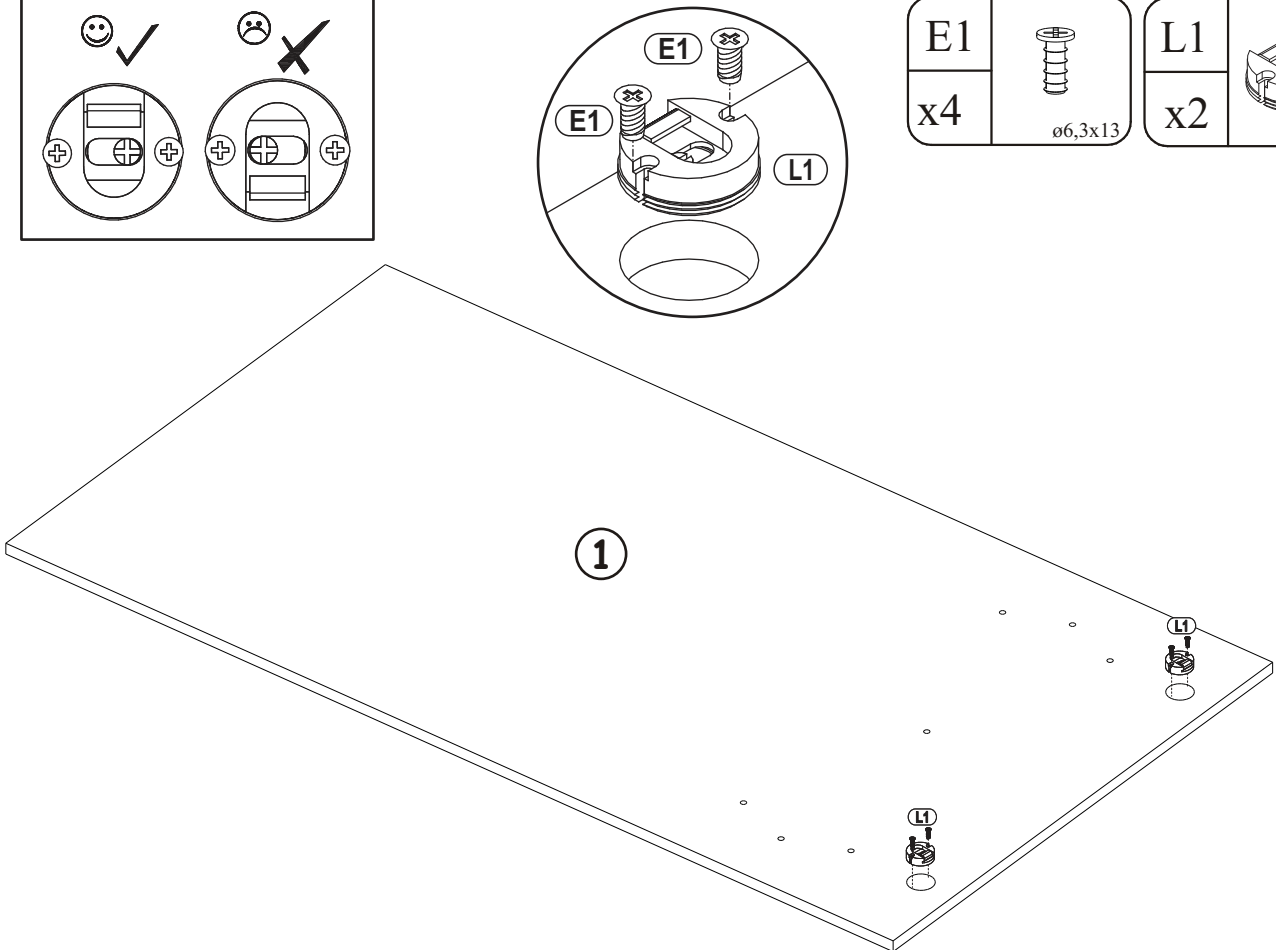

3

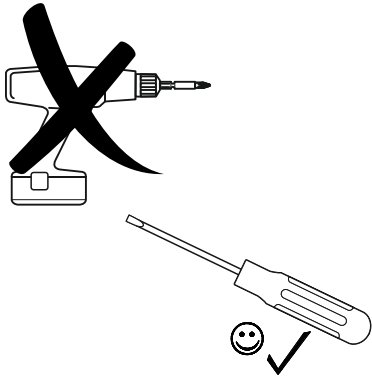
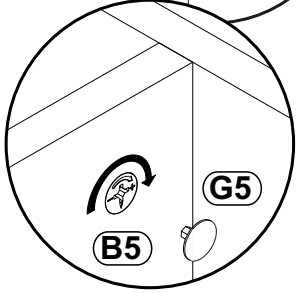
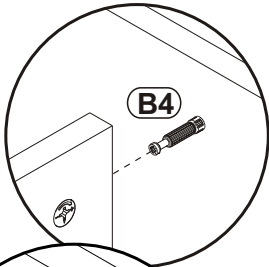

G5	
x6	

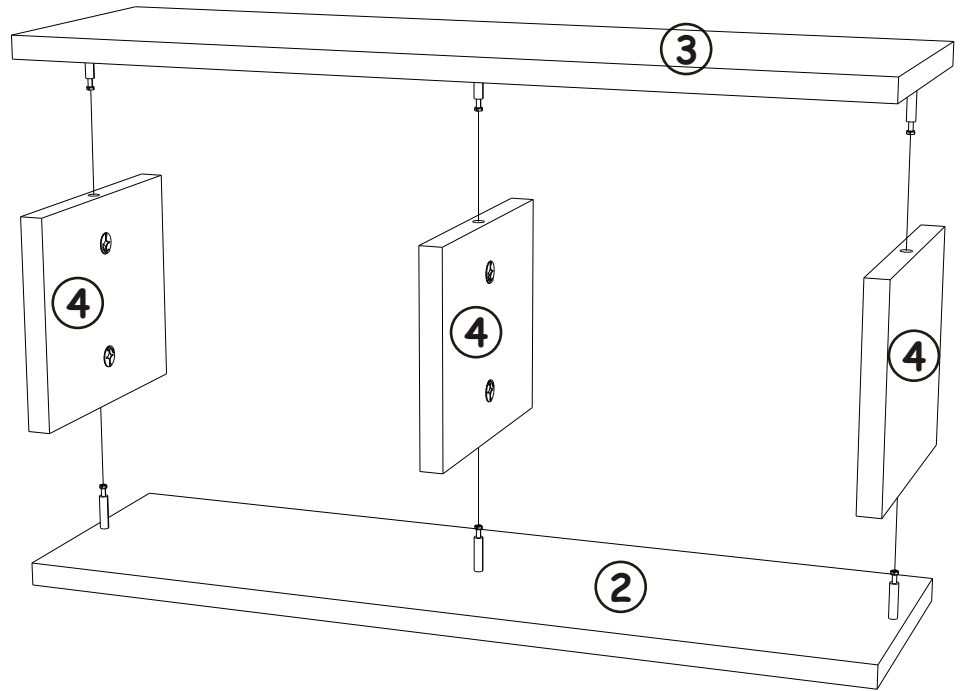

4

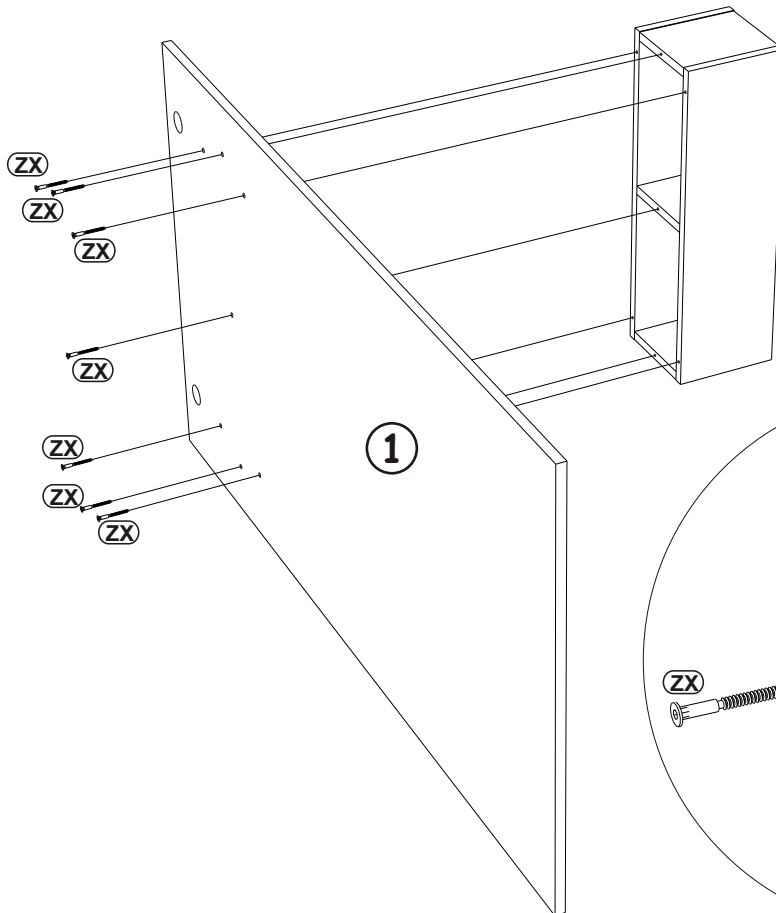

ZX	
x7	$\phi 7 \times 50$

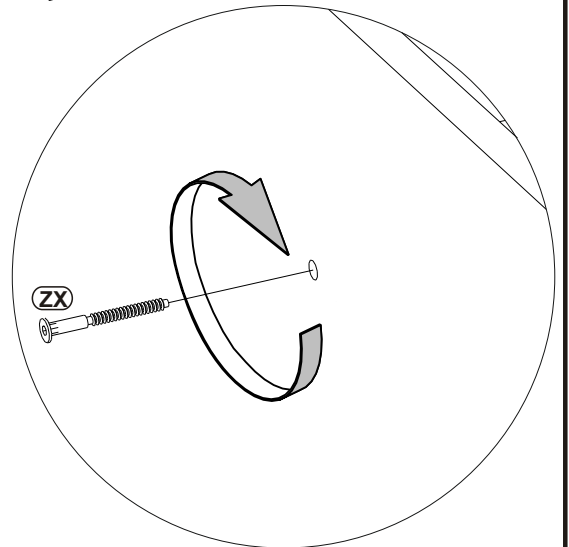

5

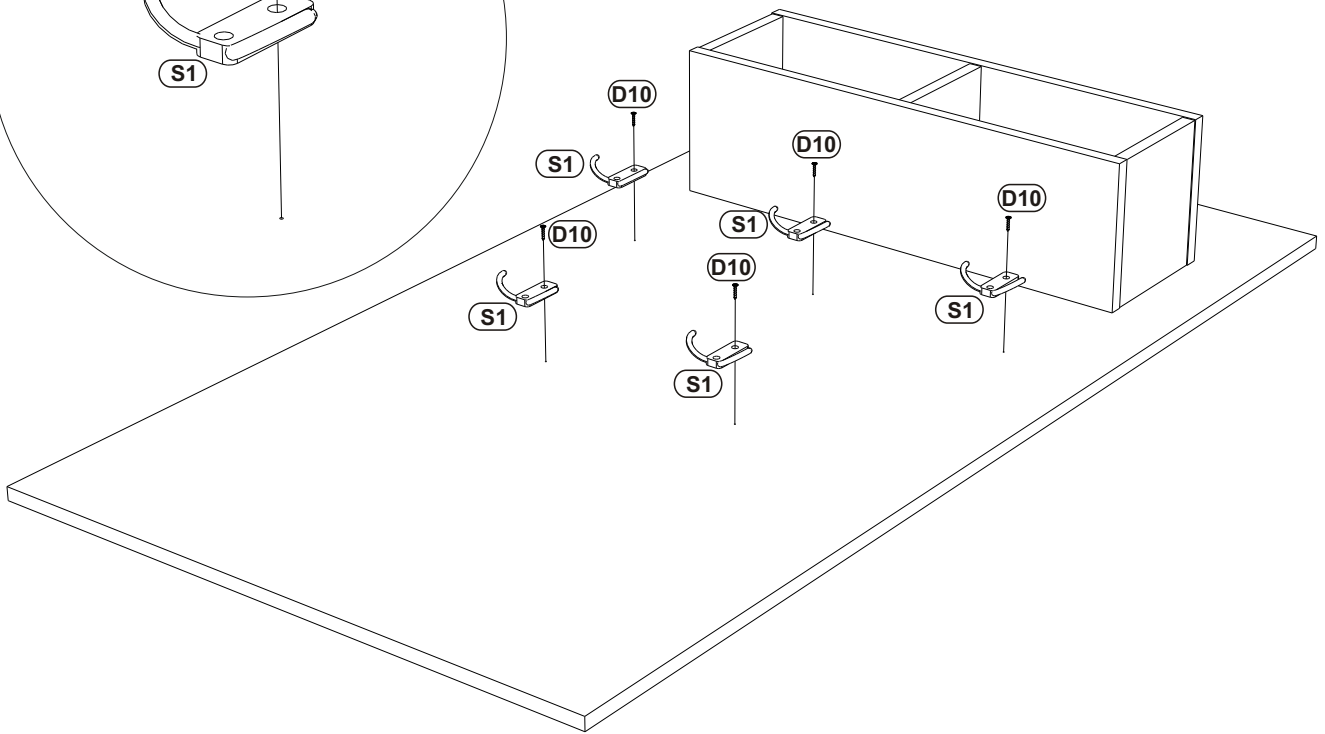
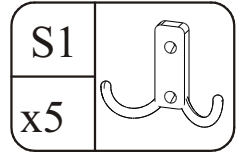
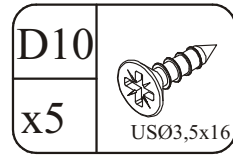
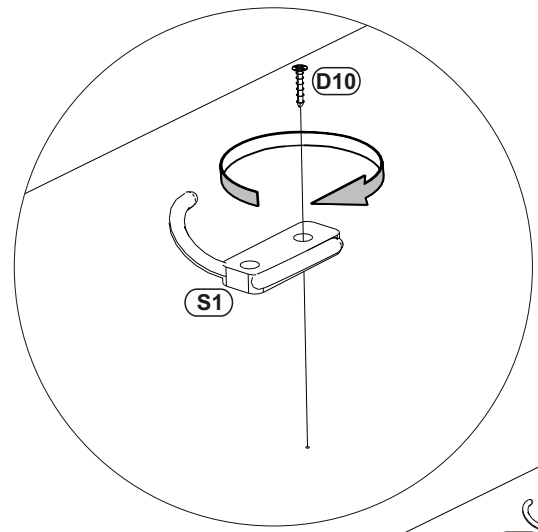

6

